

SC UNDULATOR AND SC WIGGLER FOR CORNELL ERL

Alexander Mikhailichenko, Cornell University, CLASSE, Ithaca, NY 14853

Argonne, September 21, 2010

SRI 2010 Satellite Workshop on SC Undulators and other new ID sources



Workshop 3

[← back to Complete Program](#)

Superconducting undulators and other new ID sources

September 20–21, 2010 • APS Conference Center — Room A1100

9:00 am — 5:45 pm

Organizers: Liz Moog (APS), Yury Ivanyushenkov (APS), and Toshi Tanabe (NSLS-II)

Superconducting undulators exceed conventional devices in terms of magnetic field at a given undulator period length and therefore open a way to short-period insertion devices, and thus could offer the synchrotron light source user community an opportunity of reaching higher photon fluxes at higher energies. The superconducting ID technological challenges and achievements will be covered on Monday, September 20. The topics include magnetic modeling, heat load analysis, design and construction of the superconducting devices and their components including magnetic structures, cooling systems and cryomodules, as well as magnetic measurements. The second day of the workshop on Tuesday, September 21, will be dedicated to discussions on performance of existing superconducting wigglers and undulators and the ones that are under development. The afternoon session on this day will bring presentations on new ideas for insertion devices.

OVERVIEW

The CERL (Cornell Energy Recovery Linac) is designed for up to 14th x-ray user beam lines, each equipped with its individual undulator/wiggler magnet.

The type of the undulator magnet for each beam line will be optimized on the base of the beam line requirements.

So the main requirements for undulator design are reliability, inexpensiveness in design and fabrication, flexibility of parameters.

The purpose of the beam lines range from coherent diffraction to several kinds of nano-probes.

Most of undulators should allow operation in 5-25keV region, few of them should allow operation in 1-10 keV and one-two should cover the region 100eV-5keV.

Typical length of undulator is 5m, although a possibility for installation of three 25 m-long undulators is under discussion also.

Aperture of these undulators should be as big as possible to avoid losses and heating the walls by 100 mA CERL current. The beam sigma at location of undulators is 10-15 micrometers typically, however.

In addition to the permanent-magnet undulators we are considering SC ones too

Schematics of ERL (CERL-Cornell Energy Recuperation Linac)

■ -Dump (Collimator+Kicker)

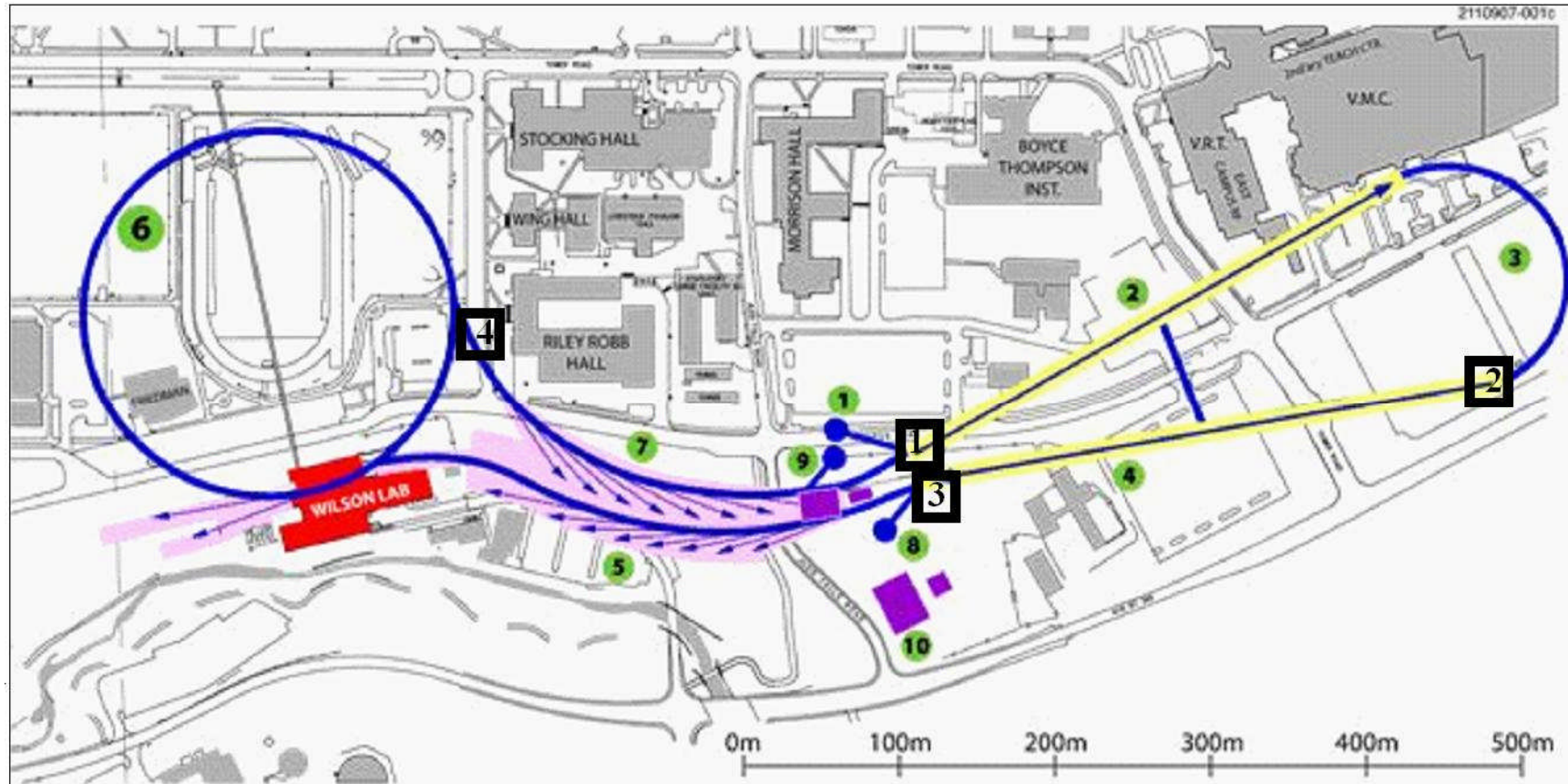

In circles:

1- Source, 2-SRF linac north, 3-achromatic bends, 4-SRF linac south, 5,7-user areas, 6-CESR ring, 8-beam dump, 9-low power dump.

**ERL will be equipped with Cryo-plant delivering ~ few kW- power at
1.8K**

**It is natural to use this capability for cooling the SC undulators and
wigglers**

Historical remark: First SC undulator with period 10 mm was tested in 1986

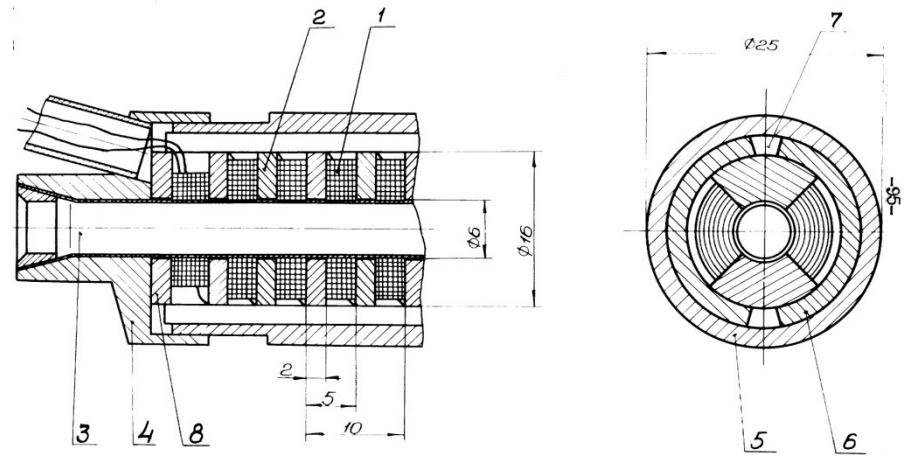
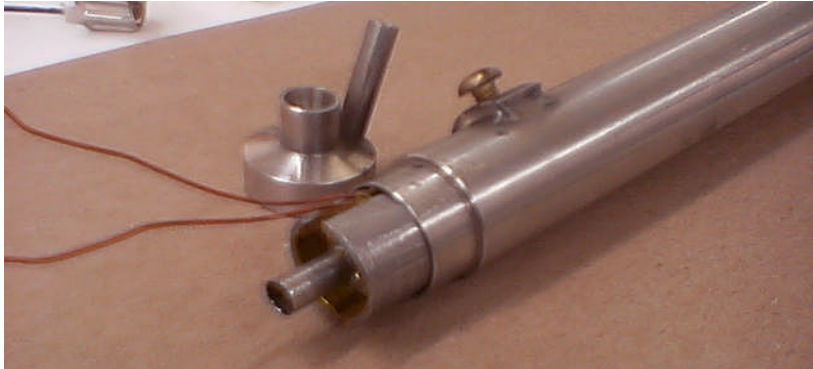

1-windings, 2-iron yoke, 3-StSteel thin-wall tube, 4-end cup, 5-helium vessel, 6-Iron yoke, 7-groove for Helium passage.



Length of undulator $\sim 30\text{cm}$, $K_{max} \sim 0.4$ (required $K=0.35$), period 10mm

At Cornell we have experience in design and fabrication of SC undulators and wigglers

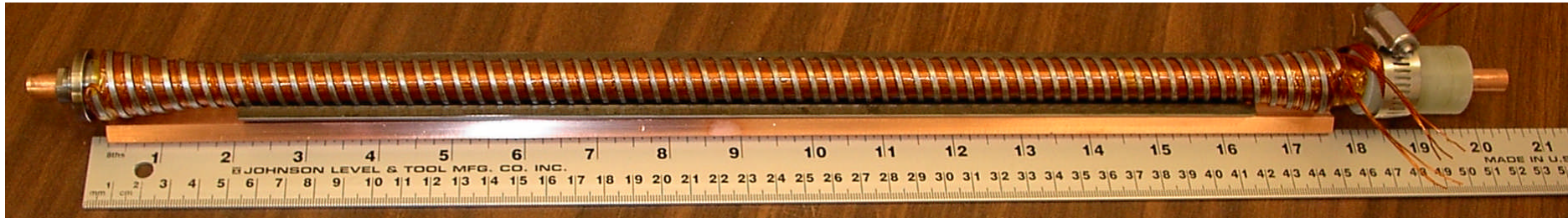

12 –mm period undulator core. Aperture available for the beam is 8 mm clear. Measured $K \sim 0.83$ (Iron yoke removed)

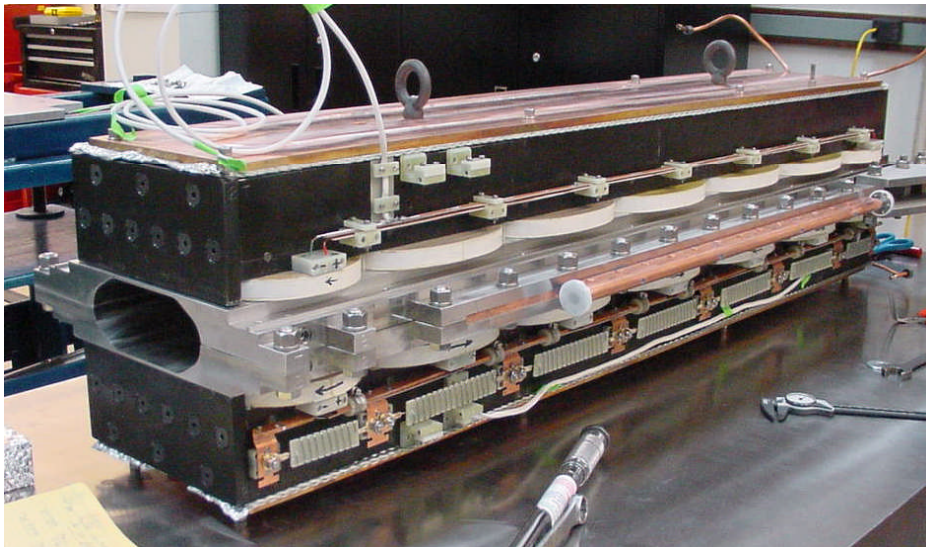

14 SC wigglers were fabricated in Laboratory during few months.

Period in main region=40cm, Field at max =2.2T

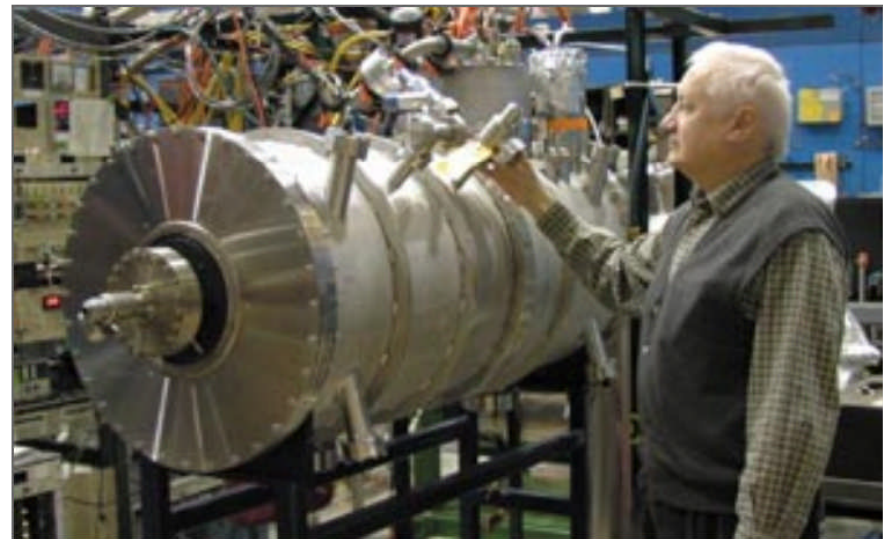

Designer Alexander Mikhailichenko with the sixth CESR-c wiggler in its cryostat on a stand.

**Wigglers give CESR a new charmed life
CERN Courier, May 1, 2003**

Dimensions were optimized for highest field;
 Coils for SC wiggler wound in forms; Squeezed in
 forms to designed dimensions;
 The epoxy quire.
 Coils keep dimensions to accuracy 0.2 mm

Three types of coils were developed

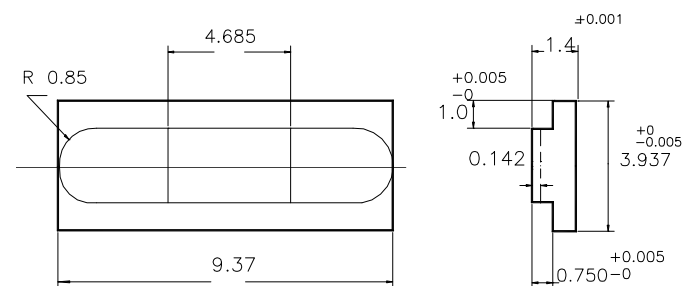
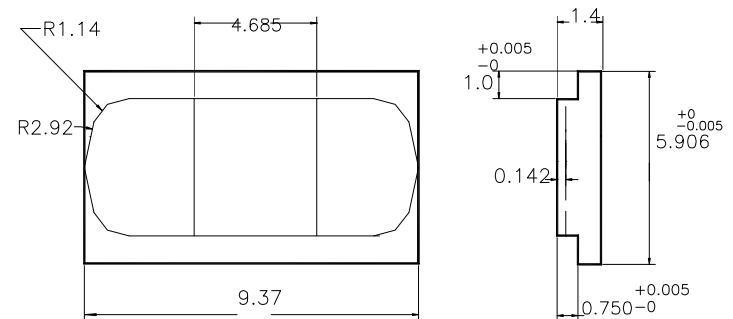
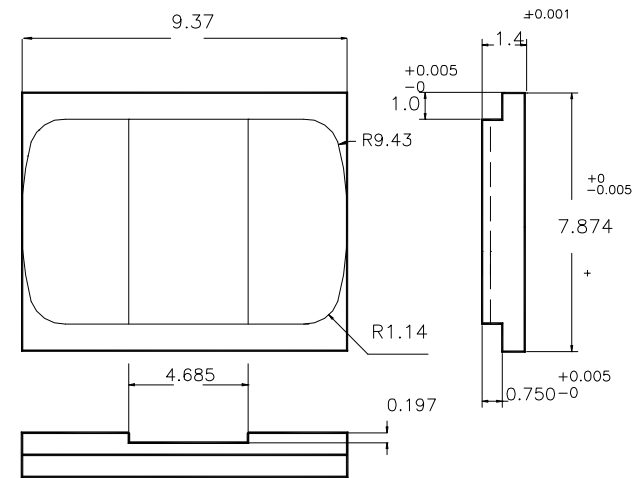
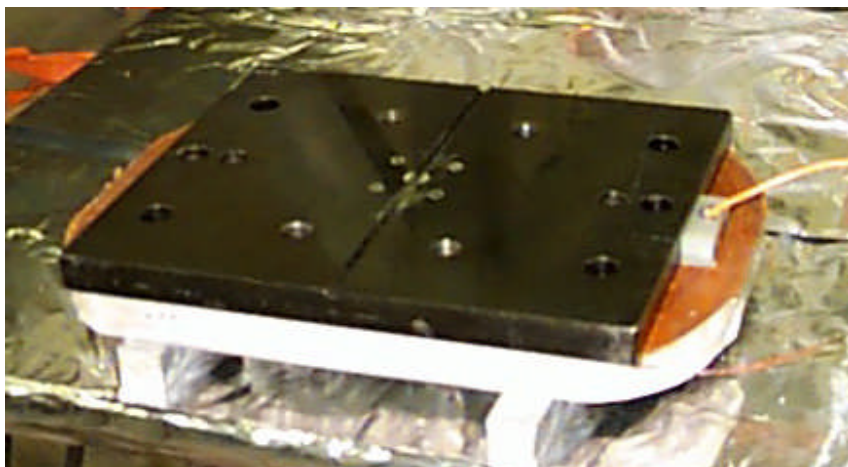
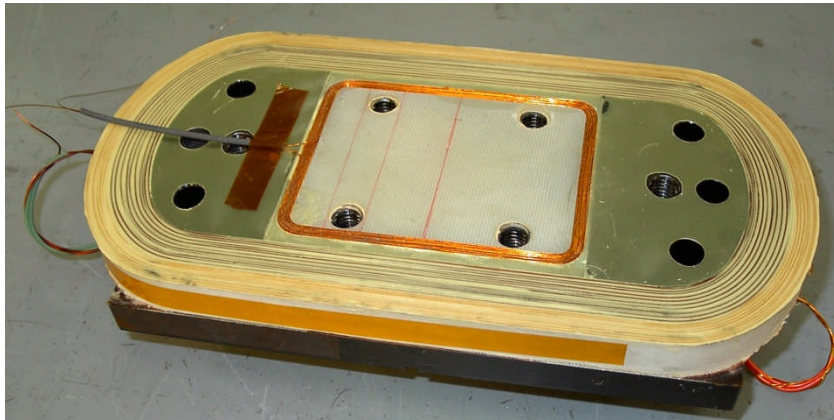

SC Undulator with period of 2.42 mm

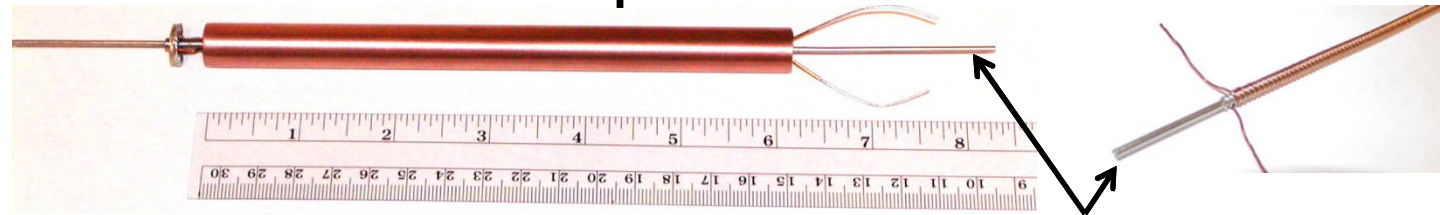

Period 2.42mm; Stainless steel tube of 1.5 mm in diameter, thickness 0.3mm

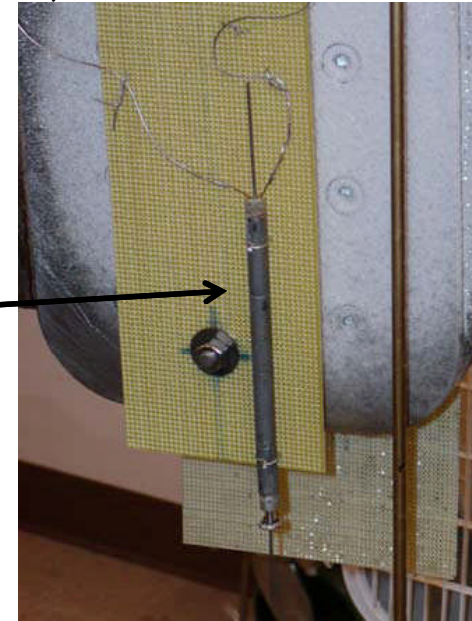
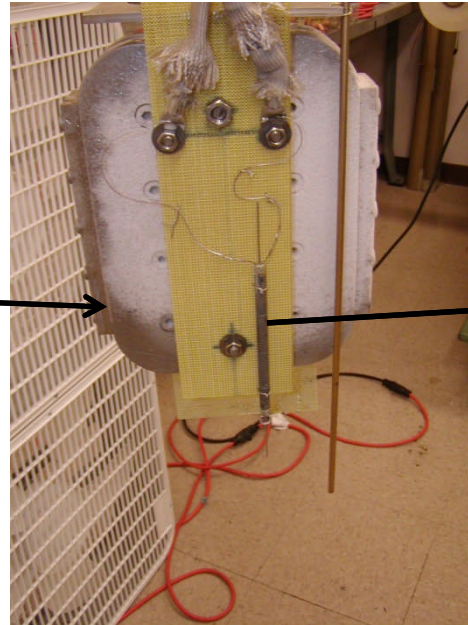

In Dewar tests we reached the current $\sim 510\text{A}$ which is close to the short sample limit. The field at the axis, according to calculations, reaches $\sim 0.34\text{T}$, $K \sim 0.08$. The field amplitude between SC wires reaches $\sim 2.3\text{T}$ in specific points inside the wire. The field was calculated with 3D code MERMAID.

A.Mikhailichenko, *Short-Period SC Undulator*, PAC03, Proceedings, pp.1957-1959.

A. Mikhailichenko. T. Moore, *First Test of Short Period Helical SC Undulator Prototype*, CBN 02-6, 2002.

ILC UNDULATOR DESIGN

Complete design done;
Diameter of cryostat -100mm

System for magnetic
measurement designed;

Undulator includes correctors
and BPMs;



HTS leads

Current input one/few modules
(ten)

3m possible

Will be extended to 2 m long ~4m total

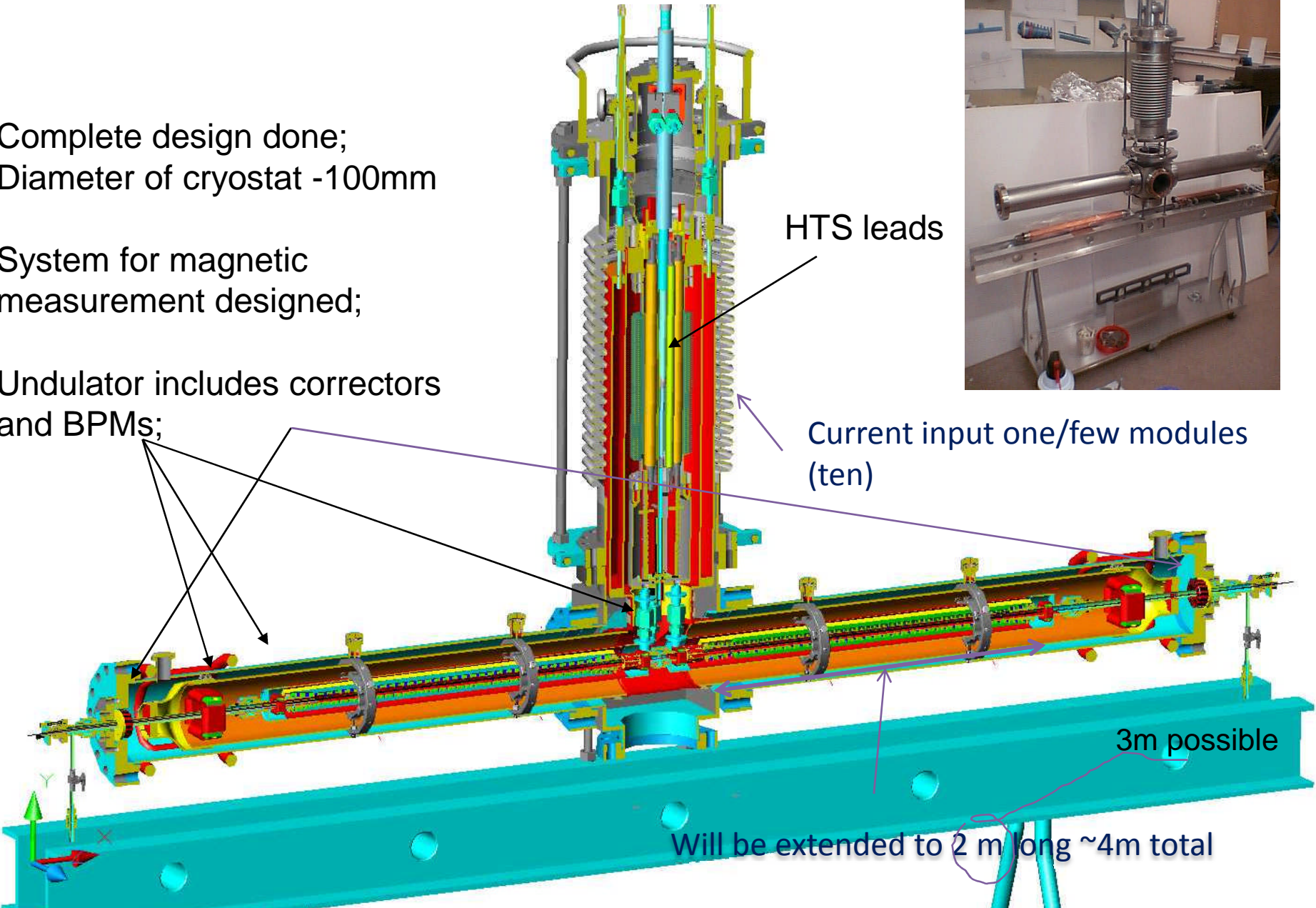

Technology developed for fabrication of continuous yoke of necessary length (2-3m)

Wire having diameter 0.33mm chosen as a baseline one for now

For 10mm period the coil has 8(z)x11(r) wires; bonded in 4strands

For 12mm period the coil has 12(z)x12(r) wires bonded in 6 strands



03/05/2007 14:44

Two meter long yoke under visual inspection by William Trusk

A fragment from the Conceptual Design report

“Since the ERL is not a storage ring, no extra horizontal aperture is required for injection and thus the ID magnets may be exceptionally close to the electron beam. So small bore devices with an inner diameter of 5 mm, become practical in either planar arrays in both horizontal and a vertical planes or in the form of a solenoid coil wrapped around a round beam pipe. With small gaps, small periods down to about twice the gap become feasible. More periods mean more flux per unit ID length. In the bigger picture of things, this is very important for compensating for not having a super-large beam current, (i.e. 100 mA design current in the CERN) vs. a 500 mA current (or more) in a storage ring.

A further design feature is to make use of the higher harmonics to push the x-ray spectrum up to 80 to 100 keV for high-photon energy experiments.

The shimming of planar undulators has been spectacular in the last several decades and has resulted in very high spectral brightness from machines such as the SLS, Diamond, Canadian Light Source, Soleil, Australian Light Source that run at 2.5 to 3 GeV whereas the first of the 3rd generation rings were positioned at 6, 7 and 8 GeV (ESRF, APS and Spring-8) just to make sure that they could produce quality hard x-ray beams (which they did and still do)”.

During design of SC undulator the following concerns formulated by users were taken into account:

- Cost per meter of the segment IDs
- Predicted Reliability over a 10 year period
- Overall complexity of mechanics and magnetics
- Radiation damage resistance of undulator technology
- RMS phase errors (in degrees) from period to period down the length of the device
- Ability to correct phase errors when observed
- Metrology to determine field qualities and errors from Hall probe, scanning wires, etc. to verify what has been produced and if this changes over years of use
- Amount of development (\$ and man hours) needed for prototype, then for production versions
- How high a harmonic number can the undulator produce good spectral brightness with compared to theory? i.e. a drop to 50% of theoretical brightness is acceptable, for instance, on the nth harmonic. How high can n be?
- How quickly (in hours or days) does it take to remove the device after a damage incident) and replace it with a spare?
- Vacuum qualities - does it take a lot of conditioning to get it ready to work in the ERL?
- How quickly (in minutes or seconds) will it take to tune from circular to linear polarization?
- How reproducible will the magnetic fields be after a change from linear to circular polarization and back to linear again? (or for any other mechanical or temperature change)
- How can the trajectory be tuned so that the integral of $B \cdot dL$ over the device length is low enough not to disturb the ERL electron optics?
- How will image currents and HOMs be picked up in the ID device?
- Will separate quadrupoles and collimators be periodically needed along the 25 m ID magnetic length device?
- What are the magnetic field tolerances needed for a 1000-pole undulator to have a relative line width equal to 1 divided by the number of periods? i.e. $\Delta E/E = 1/1000 = 0.1\%$.

HEATING BY THE BEAM

Heating of vacuum chamber by imaginary current reduced here, as the resistance ρ of Copper at Helium temperature becomes lower by RRR factor. For RRR=600 and estimated frequency of harmonics corresponding to the pulse with duty $\tau \sim 2\text{ps}$ ($\sim 385^{\text{th}}$ times of main harmonic of CERL RF, which is $f_0 = 1.3\text{ GHz}$), resistance of 1m-long piece (100 cm) of vacuum chamber having diameter $d = 0.6\text{ cm}$, average current $I = 100\text{ mA}$ defined by normal skin effect comes to

$$R[\text{Ohm} / m] \cong \frac{1.72 \cdot 10^{-6} [\text{Ohm} \cdot \text{cm}]}{\sqrt{600} [\text{RRR}]} \frac{100 [\text{cm}]}{\pi \cdot 0.6 [\text{cm}] \cdot 1 [\text{cm}] \cdot \sqrt{50 [\text{Hz}] \cdot 2 \cdot 10^{-12} [\text{Hz}]} \cong 0.34$$

where is was taken into account that for 50 Hz the depth of skin-layer at room temperature is 1 cm. Conservative estimation for losses by normal skin effect can be done as

$$P[\text{W} / m] \cong I^2 R \frac{1}{\tau f_0} \cong 1.1$$

For such short pulses $\tau \sim 2\text{ps}$ at low temperature the process is well under anomalous skin effect phenomenon, however.

Really, normal skin depth is $\delta_n[cm] \cong \sqrt{\frac{50[Hz] \cdot 2 \cdot 10^{-12}[Hz]}{RRR}} \cong 0.38 \cdot 10^{-6}$

The mean free pass length ratio to the conductivity is not function of temperature as

$$\frac{1}{\rho} \cong \frac{ne^2 l_{free}}{p_F} \cong \frac{ne^2 l_{free}}{\hbar n^{1/3}}$$

where p_F is Fermi momentum, n is electron density. So the free electron pass can be evaluated as

$$l_{free}[m] \cong \frac{1}{\rho \cdot 1.54 \cdot 10^{15}} \cong \frac{1}{1.72 \cdot 10^{-8} \cdot 1.54 \cdot 10^{15}} \cong 0.38 \cdot 10^{-7} (= 0.38 \cdot 10^{-5} cm)$$

So one can see that the free electron path is bigger than the normal skin depth~ 10 times.

As $\delta_{an}^3 \cong \delta_n^2 \cdot l_{free} = \delta_n^3 \cdot (l_{free} / \delta_n)$ (Landau, Lifshits)

the losses due to anomalous skin effect will be less in ratio $10^{1/3} \sim 2.1$ times coming to **$P=0.55W/m$** .

Anyway, presence of low conducting boundary is better for the impedance budget; so impedance of SC undulator will be less than for room-temperate undulator.

Anomalous skin effect helps in reduction of losses

SC UNDULATOR

- SC windings able to generate magnetic field of opposite helicities, including elliptic and a linear one oriented as desired.
- For undulator period 15-25mm, aperture 5-8mm, length up to 10m (single piece), K factor could be changed from zero up to 1.5 by changing the feeding current.
- No mechanical motion required.
- Design is based on earlier idea - **D.F.Alferov, Yu.A.Bashmakov, E.G.Bessonov, "Device for Obtaining Polarized Electro-magnetic Radiation", Authors Certificate N° 538508, USSR.**

Now with usage of SC wires this idea becomes practical.

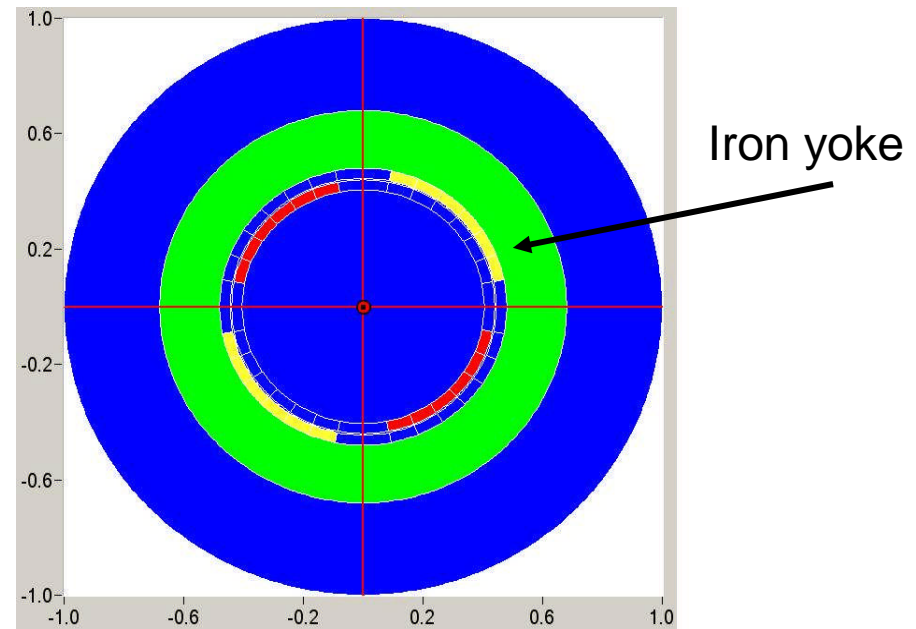
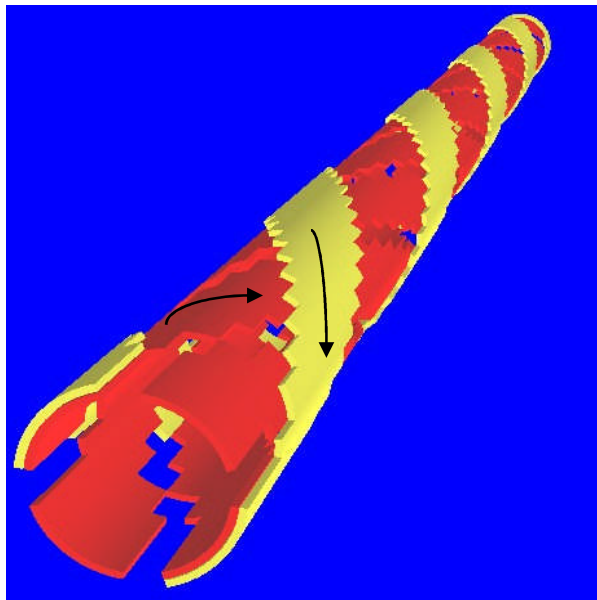

- SC undulator has two-layer coil set; inner layer carries conductors for one helicity, upper layer-for opposite helicity.
- Lower layer delivers ~20% higher field values for its helicity. Linear polarization for SC undulator could be oriented in arbitrary direction. Parameters of SC undulator are given for the **upper** layer (bore diameter 6 mm). For operation of undulator three set of windings and three power supplies required. One of them serves for rotation of the plane of polarization in arbitrary direction.
- By changing the currents in the windings it is possible to arrange any polarization –from a linear one to the circular one and vice versa. Third winding having the same helicity as one of already existing, but shifted in longitudinal direction by a half period, could be added for change the orientation of linear polarization in arbitrary direction.
- Installation of coils in Iron tube ~doubles K factor. This might be a good margin. Utilization of thicker wire could also increase field value; all final parameters must be defined by user. although UR specifically associated with $K < 1$.

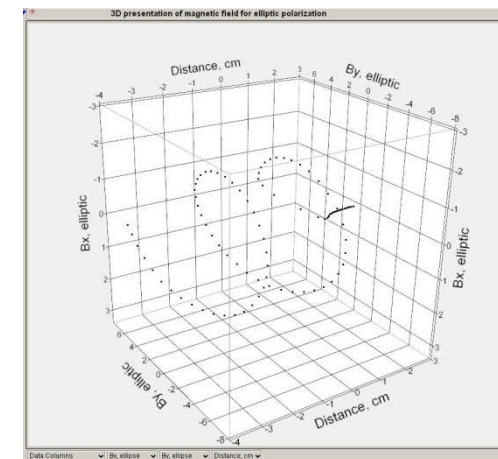
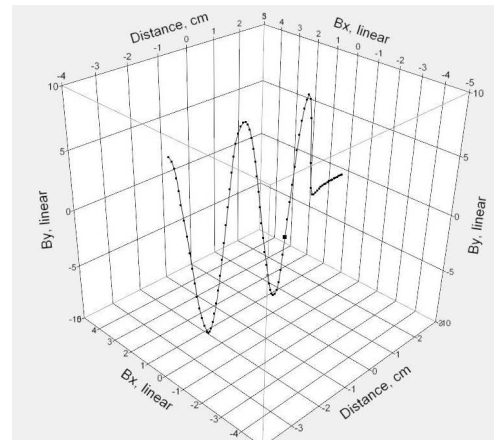
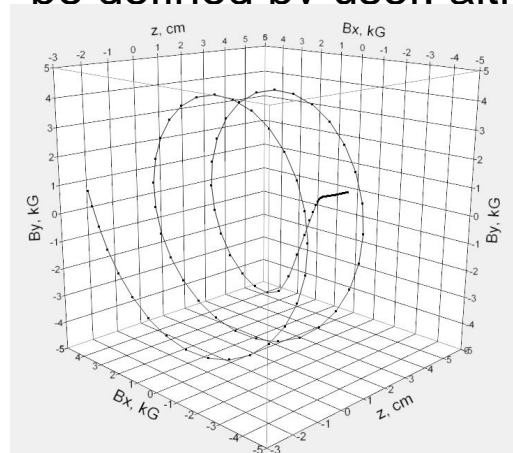

Field reachable in an undulator as a function of its period. 5-mm clear bore diameter suggested.

Period[mm]	Bmax [T]; helical mode	Bmax [T]; planar mode
24	1.097	2.194
22	1.058	2.116
20	1.009	2.018
18	0.950	1.899
16	0.868	1.736
14	0.792	1.586

PROTOTYPE MODEL

- To identify the difficulties the real model was fabricated with SC wire of 0.3mm in diameter.
- Winding of model coils was done on Oxygen free Copper thin-wall tube of 8 *mm* in inner diameter and period of $\sim 25\text{mm}$, having length $\sim 45\text{ cm}$. The tube wrapped by 0.5 mills-thick Kapton tape. We used ribbon-type flat 6 wire strands stick together with Formvar for winding. Bare wire diameter is 0.3 *mm*, insulated-0.33 *mm*, ratio of SC to Copper is 1.2:1. First layer has 48 wires total, the outer layer has 2x12 wires.
- HTS tape can be used in this design in a future as well.

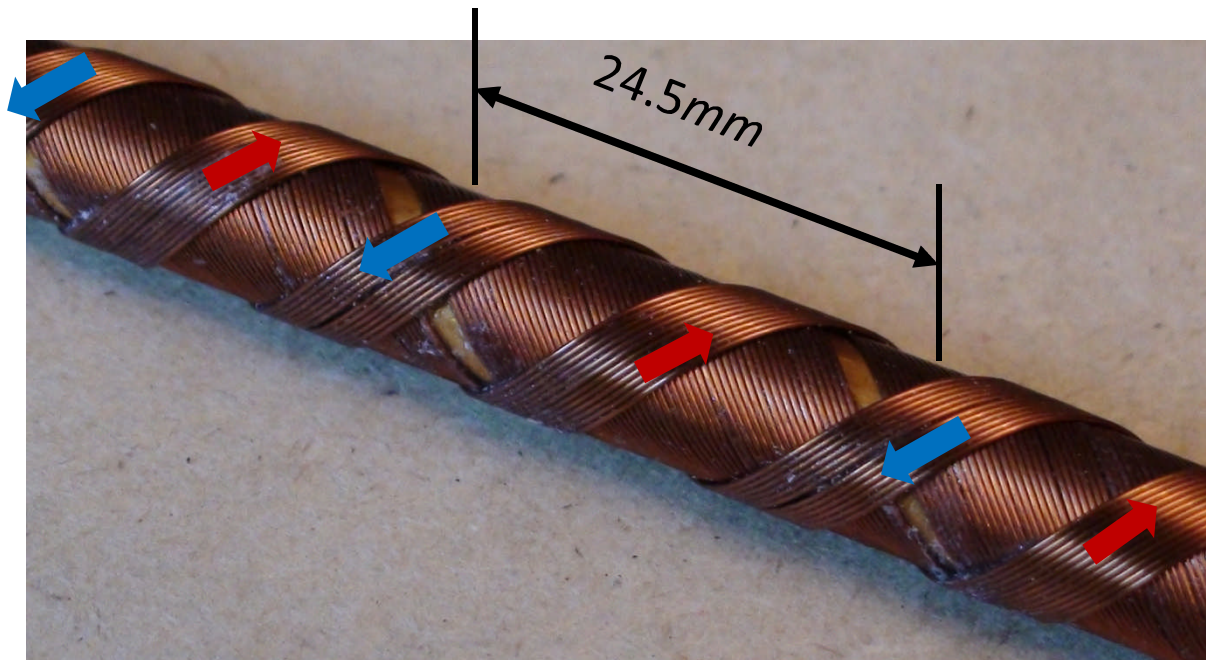

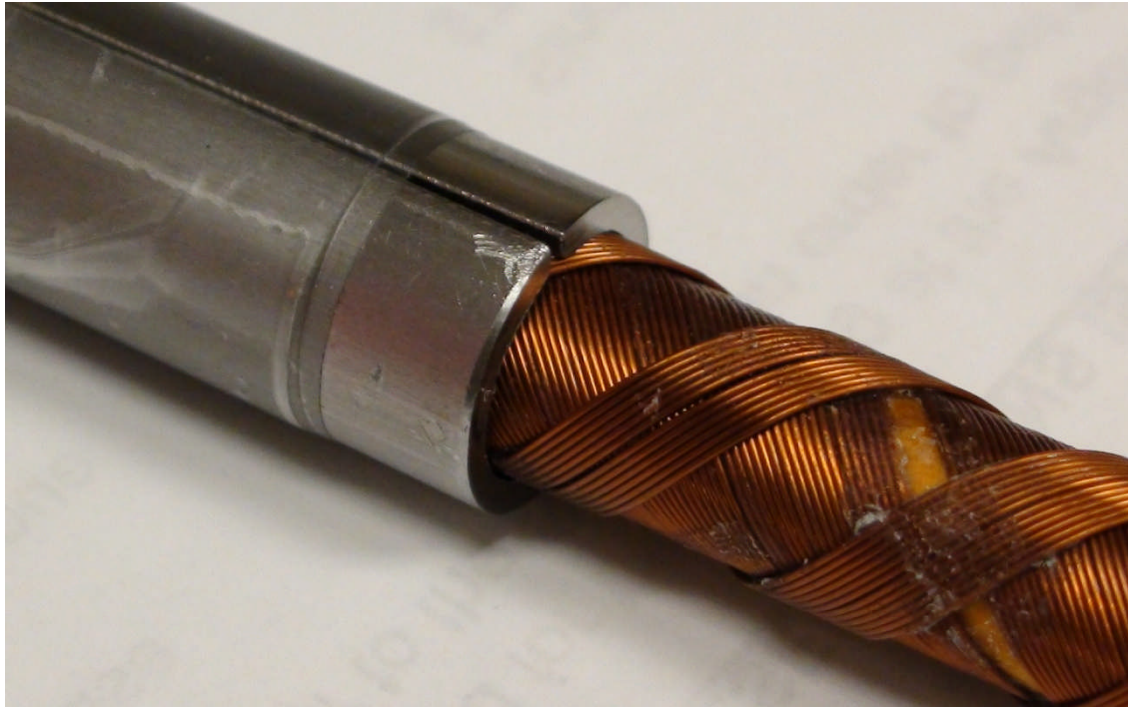

Iron yoke ~ doubles K factor

All parameters represented for the upper-layer current.
The same current in a lower layer delivers ~20% higher field at the axis.

OVERALL DESIGN

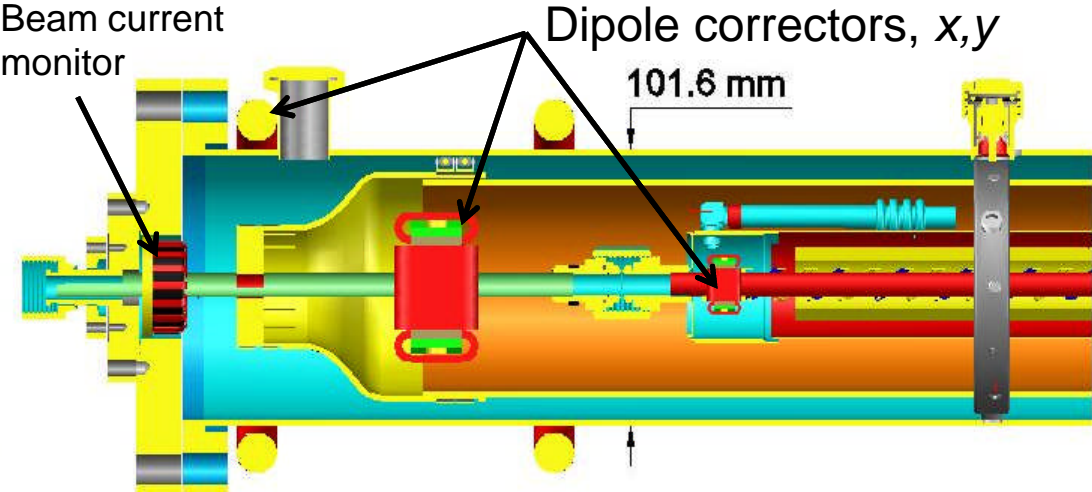
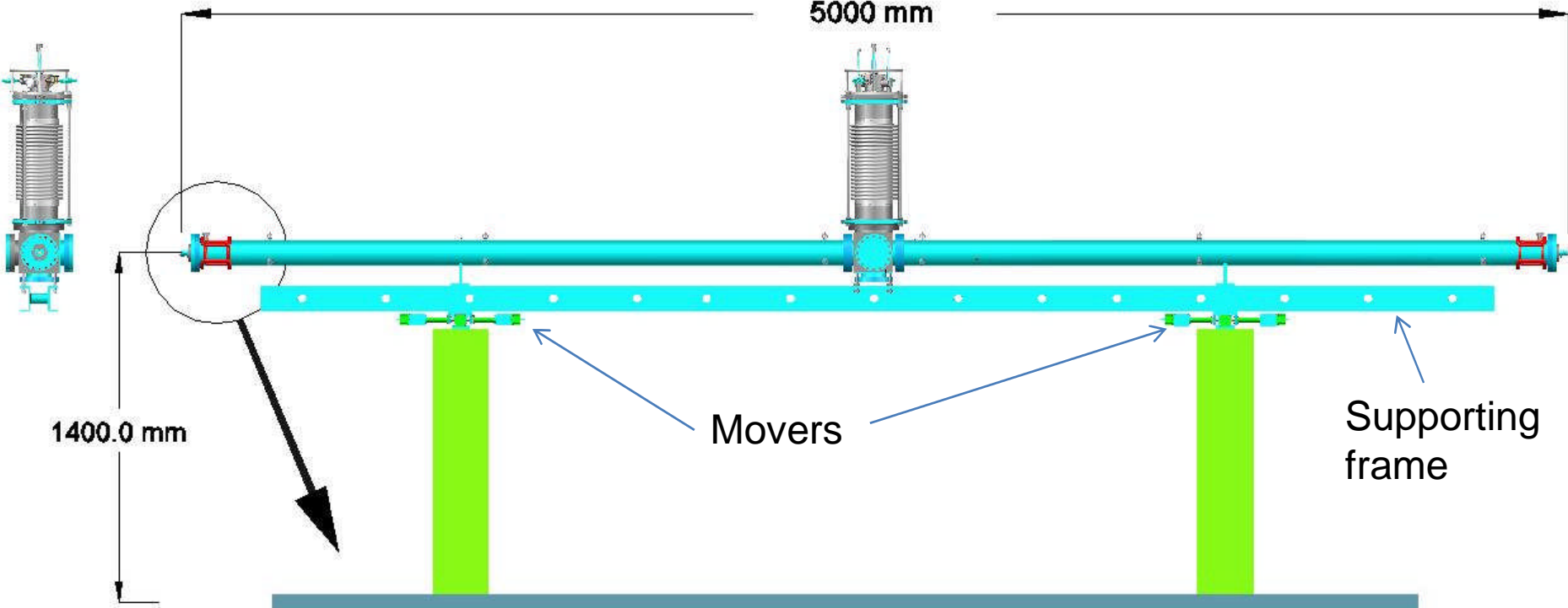

SC Undulator	
Length	5m
Diameter	101.6 mm
Period	22 mm
Bore	Ø 6 mm
Peak Field	1 T helical / 2 T planar

- SC undulator is a lightweight device.
Weight of 5-m long section can be estimated as 120kg, including supporting frame and positioning mechanisms.
- Few different types can be fabricated in Lab at low cost (150k\$ each).
- Replacement by spare one in a case of incidental damage a matter of hour or so.
- Device is ready to work right after the cool down, which might take $\sim\frac{1}{2}$ hour as there is no big mass involved here.
- Change of helicity at full current takes \sim few sec –will be identified while testing a prototype.
- As the vacuum chamber which is looking to the beam (made from OFC) is cooled down to Helium temperature, the vacuum is not a problem due to cryo-pumping. Additional pumping stations will be located between sections of undulator, unified with collimators.

SC WIGGLER FOR CORNELL ERL

In addition to undulator described above, we considering a planar superconducting wiggler as well. Period of this wiggler was chosen to be ~ 5 cm, vertical full gap available for the beam ~ 7 mm.

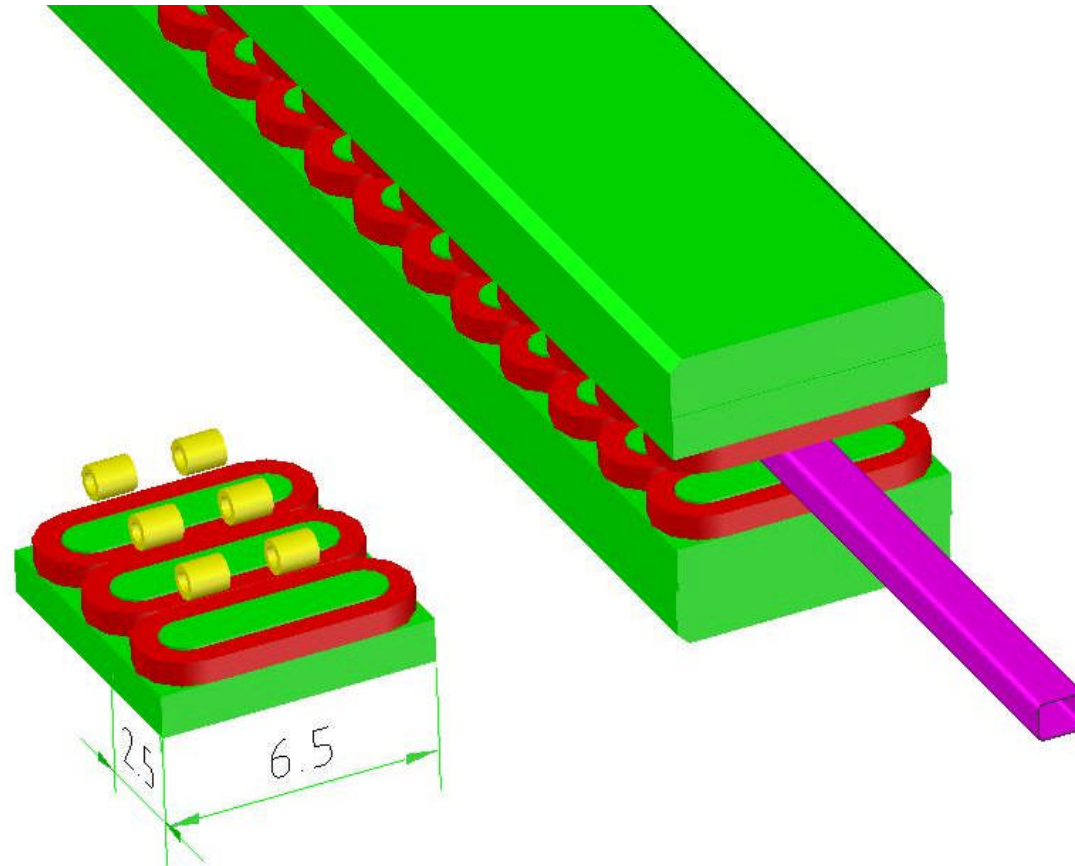

At the left: Three individual poles. Dimensions are given in centimeters. Cylindrical coils serve for generation of horizontal field. At the right: Individual poles installed on the plates.

HOW THE IDEAL WIGGLER LOOKS LIKE

Representation of a wiggler as a series of quadrupoles with *transverse* orientation.

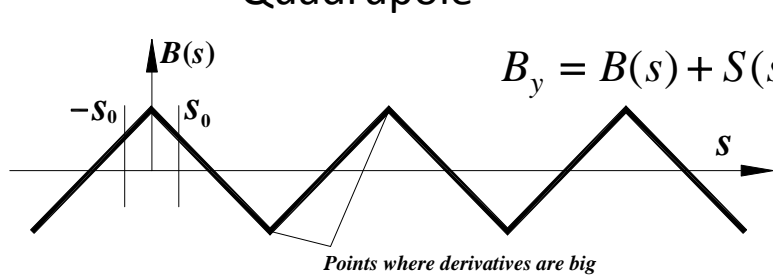
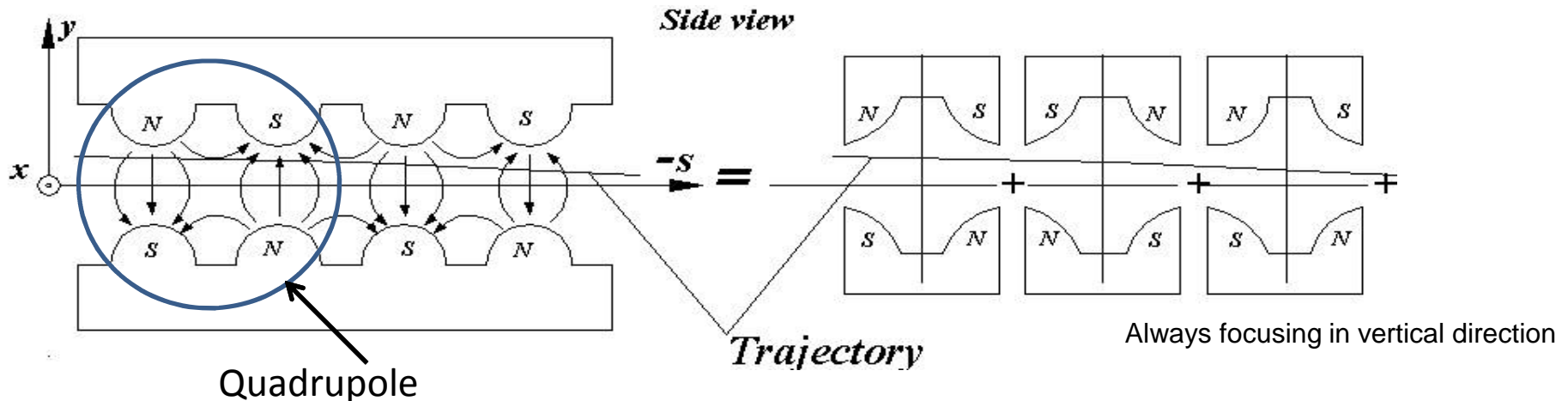

$$B_y = B(s) + S(s)(x^2 - y^2) - \frac{x^2 + 3y^2}{8} B''(s) + D(s) \cdot (x^4 + y^4 - 6x^2y^2) + \dots$$

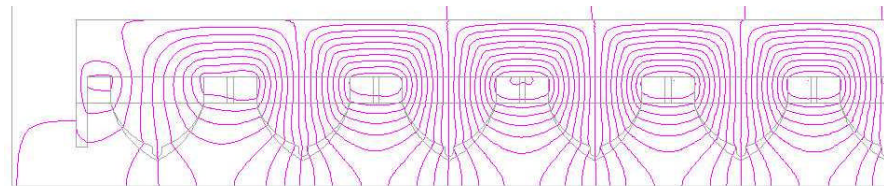
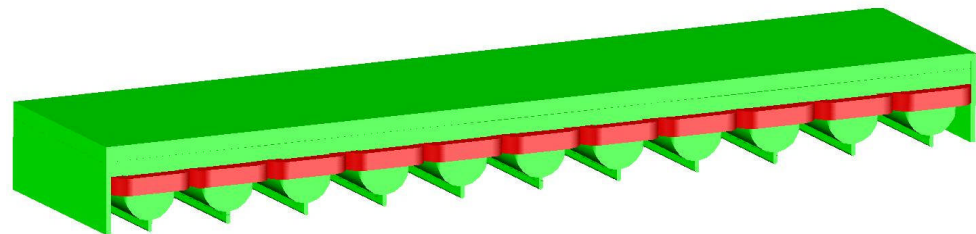

Longitudinal profile of magnetic field with linear dependence between extremes is ideal for linearity of motion.

All aberrations associated with the even derivatives along s .

A.Mikhailichenko, Wiggler for ILC cooler, EPAC06, WEPLS064, 2006.

A.Mikhailichenko, Spherical Aberration-Free Wiggler, EPAC08, WEPP156, 2008.

CALCULATIONS

Calculations carried with MERMAID show, that field ~4T could be achievable here. This brings critical energy of the photon to

$$\varepsilon_c(\text{keV}) = 0.665 E[\text{GeV}]^2 B[\text{T}] \cong 0.665 \cdot 25^2 \cdot 4 \cong 66$$

what means that the flux at ~100 keV will be just ~5 times lower, than for 66 keV.

Yoke made from Steel 1010 which demonstrated perfect characteristics at helium temperatures. SC wire with diameter 0.6 mm has a critical current ~700 A (~400A@4T). Multi-turn windings, 12x10, racetrack style, surrounding each pole.

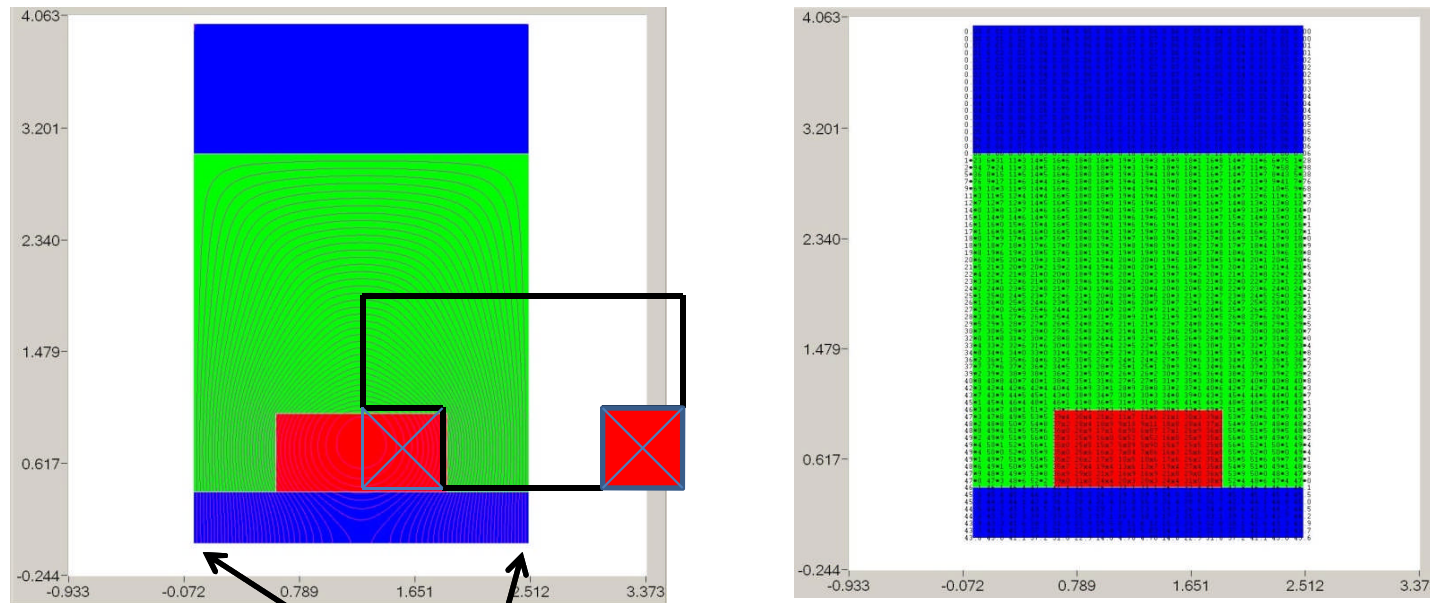

Planes of symmetry

~7.5% higher, than 4T

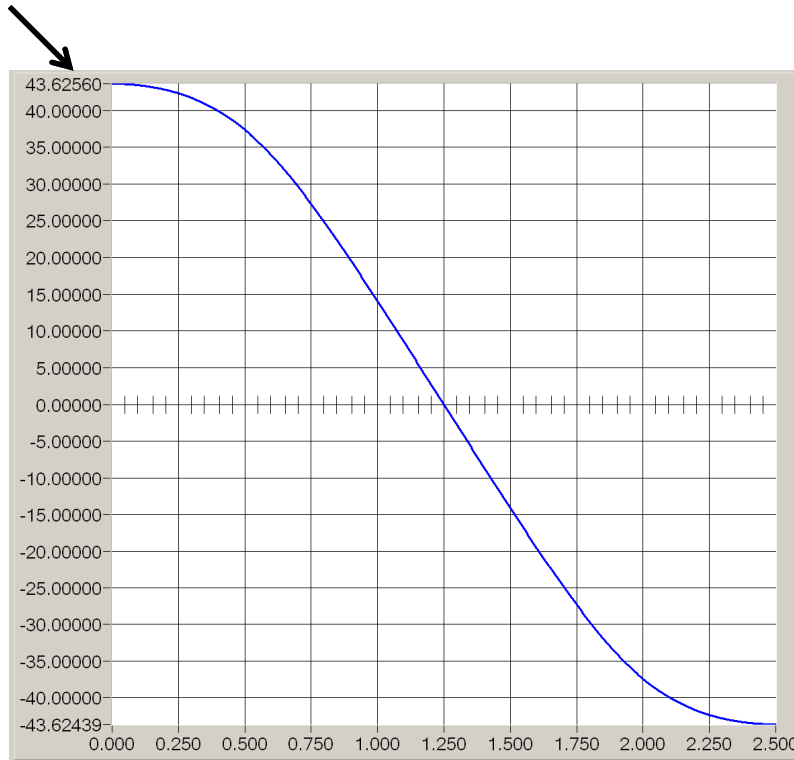

Graph of a vertical field along half period.
Field in *kG*, longitudinal dimension –in *cm*.

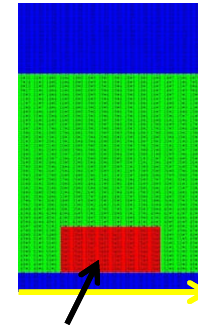

Current from *two* coils here

Total current in a coil~37.5 kA,
i.e. 312.5 per wire

As $J_c \sim 400A @ 4T$ so this is 78%
of short sample limit

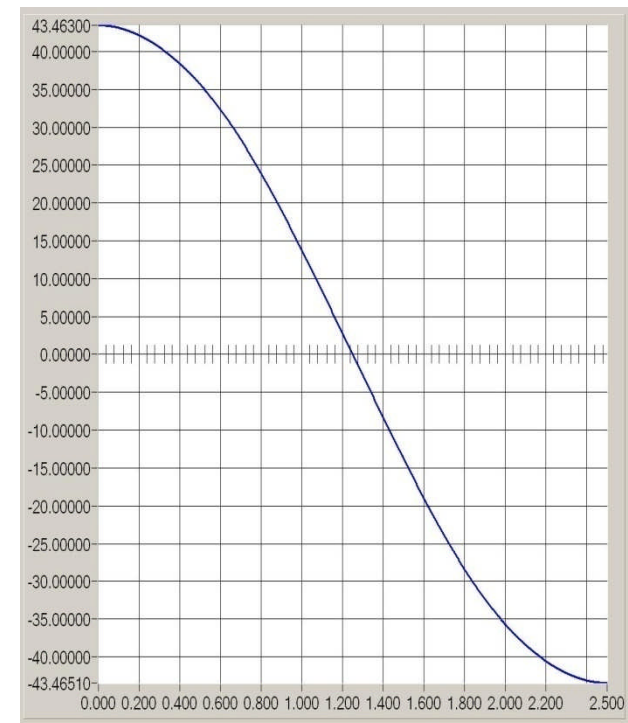
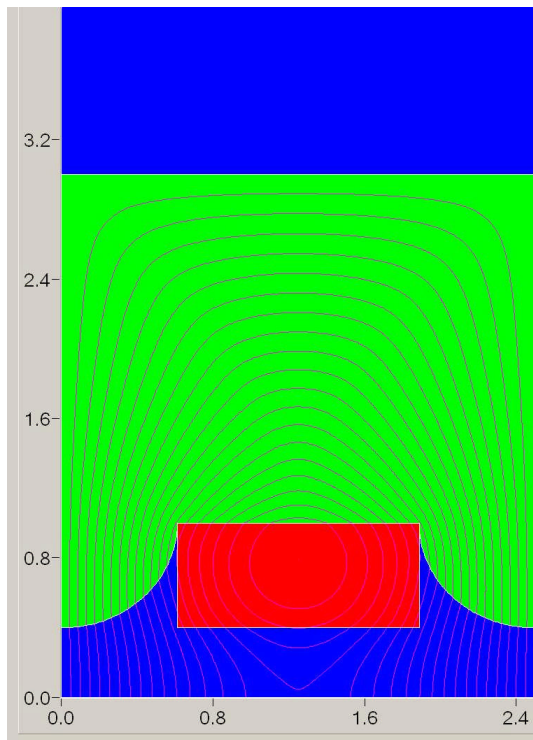
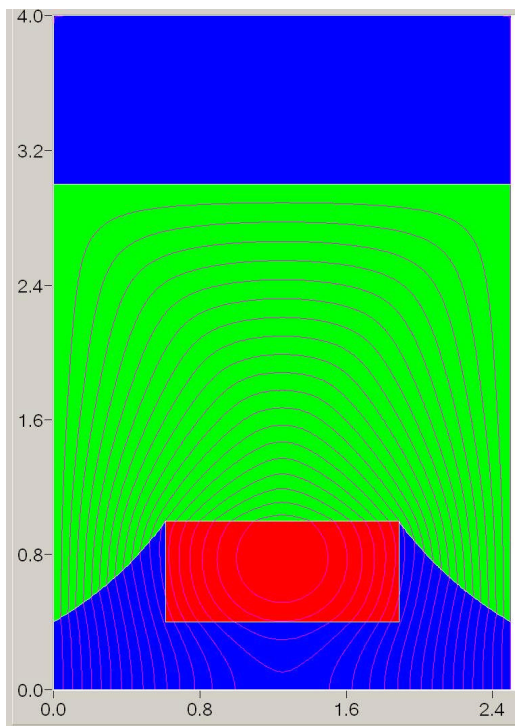

For $\sim 4\text{T}$ high field level, Iron is deeply saturated and profiling poles *do not give advantage*, however.

At lower field this trick with profiled poles is working

COILS FOR GENERATION OF HORIZONTAL FIELD

In addition to linear polarization, this wiggler is able to generate elliptically polarized radiation with ellipticity $\sim 70\%$. For this purpose the trajectory of electron should have a slope $\sim 1/\gamma$ in vertical direction in a region with maximal vertical field. The coils generating horizontal field located between main coils; longitudinally their axis lies in planes separating the main coils,

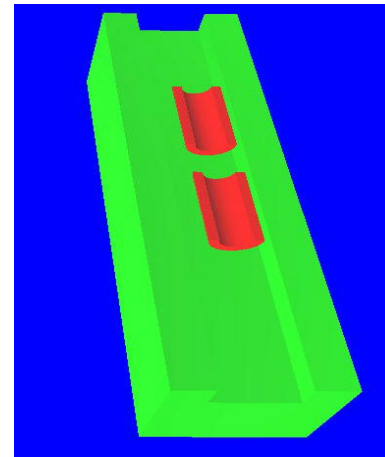
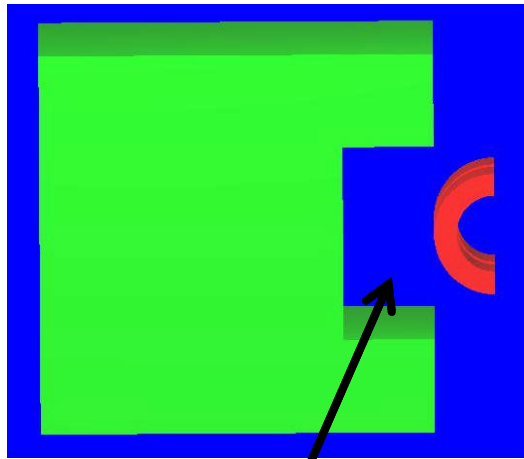

Main coils located here. Not shown in Figures.

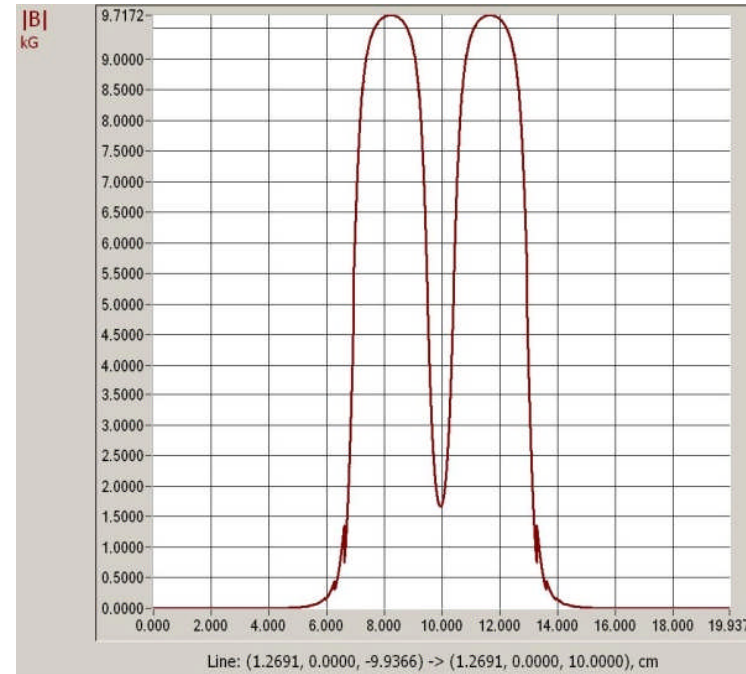
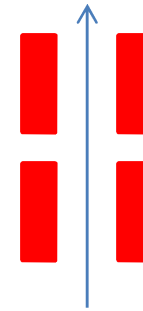
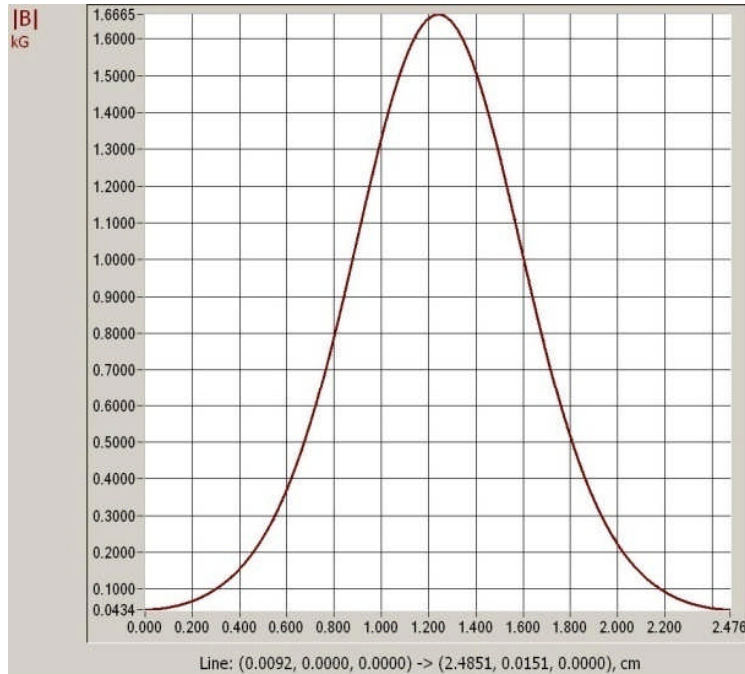
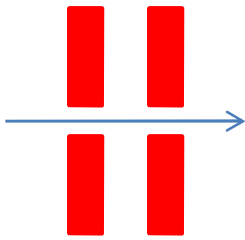

At the left: The field graph across the coil in a median plane.

At the right: The field along the coils axes from the bottom to the top.

OVERALL DESIGN

Cold mass consists of two identical pieces separated by two spacers located at each side of cold mass. Each coil wound on its core. Then cores attached to the long bar serving for the rigidity purposes and for returning the magnetic flux.

Coils for generation of horizontal field attached to the spacers; all coils connected in series. Together all construction held by bolts. This assembly inserted into 4" tube, which serves as a Helium vessel.

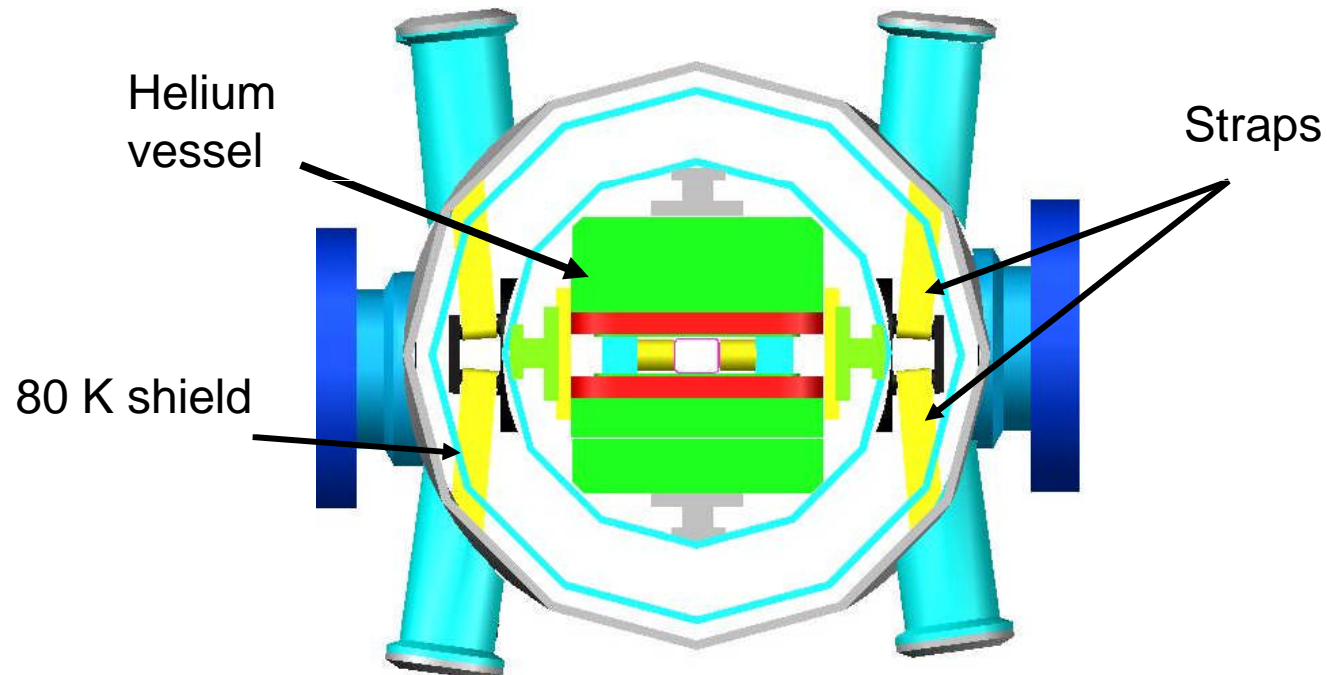

Vacuum chamber ~12x7mm

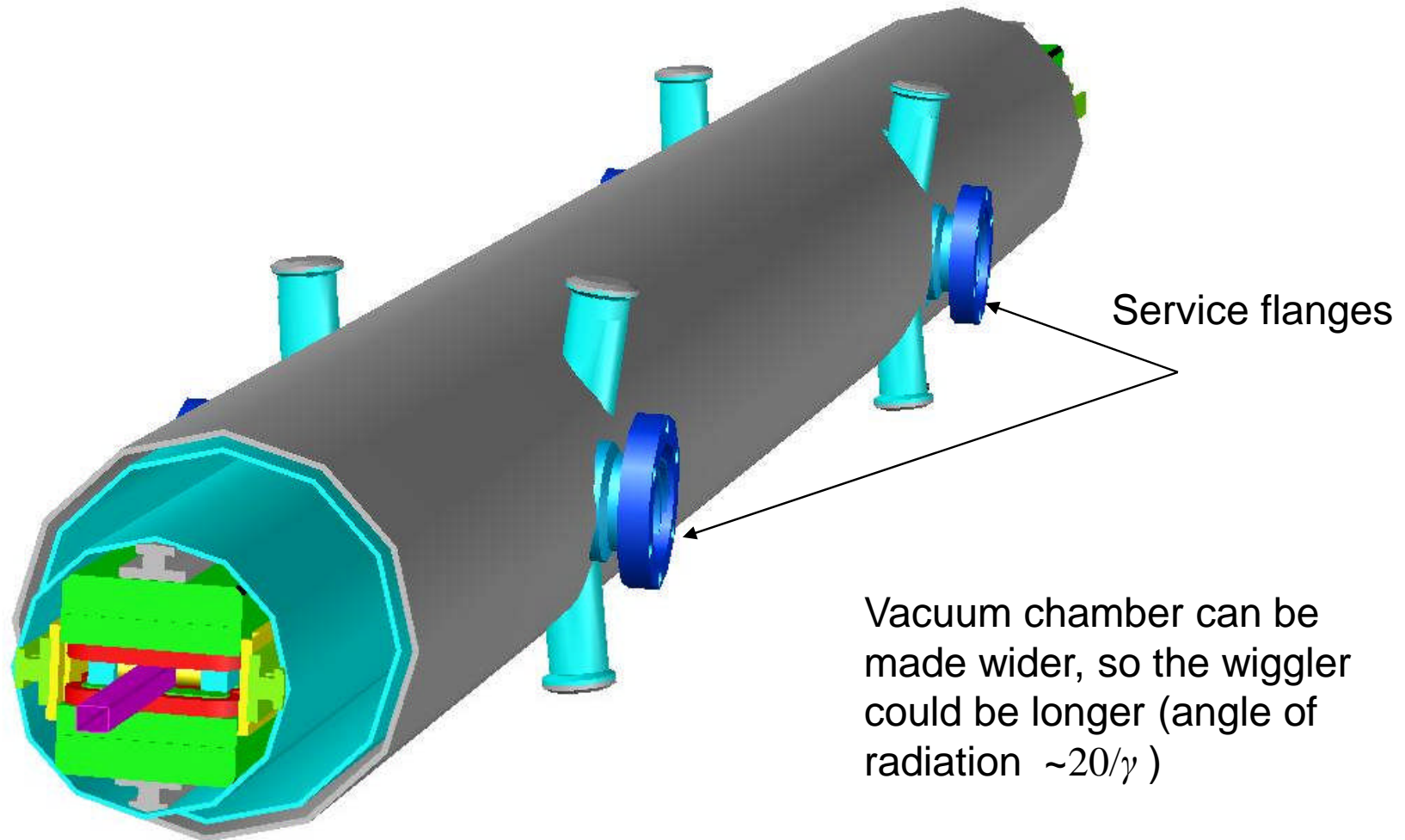

Weight of this <3-m long wiggler is about 240kg

Design will allow rotation the wiggler $\pm 45^\circ$ along the beam axis

Right now the Helium line runs along CESR-C $\sim 100\text{m}$ in the tunnel- not a problem

Appendix A: SHAPE OF SPECTRUM

Shape of spectrum of any undulator *is not* a function of the number of poles-it is the same practically for the 20-pole and 2000-pole undulator and described by the universal curve, if normalized by the total intensity. This could be seen from the following.

Spectral distribution of intensity of radiation generated by a particle in a finite-length helical undulator can be represented as the following [5]

$$\frac{dI_{\omega}(\xi, M)}{d\xi} = \frac{e^4 H_0^2 \gamma^2}{\pi m^2} \int_{1/2}^{\infty} \frac{dy}{y^4} (1-2y+2y^2)(1+(2\xi y)^2) \frac{1}{\pi M} \frac{\text{Sin}^2(2\pi M \xi y)}{(1-(2\xi y)^2)^2}, \quad (\text{A1})$$

where $\xi = \hbar\omega / \hbar\omega_c$ is the energy of photon normalized to the cut-off frequency

$\omega_c \cong 2\Omega\gamma^2 / (1+K^2)$, $\Omega = 2\pi c / \lambda_u$, λ_u is a period of undulator, $y = \gamma^2(1-\bar{n}\bar{v}) \cong \frac{1}{2}(1+K^2 + \gamma^2\theta^2)$, $\hbar = 1 = c$, M is the number of poles.

Shape of curve $\frac{dI_{\omega}(\xi, M)}{d\xi} \frac{\pi m^2}{e^4 H_0^2 \gamma^2}$ weakly depends on M if $M > 10$. For the infinitely long undulator, $M \rightarrow \infty$

$$\frac{dI_{\omega}}{d\xi} = \frac{2e^4 H_0^2 \gamma^2}{\pi m^2} \xi \cdot (1-2\xi+2\xi^2) = I_0 \cdot \xi \cdot (1-2\xi+2\xi^2). \quad (\text{A2})$$

For the planar undulator the spectral density is $\frac{1}{2}$ of the (A1).

So, for machines like ERL, where the beam has significant average power, there is no necessity for a long undulator.

[5] V.N.Bayer, V.M.Katkov, V.M.Strakhovenko, "Electromagnetic Processes at High Energy in Oriented Monocrystals", Novosibirsk, Nauka, 1989, ISBN 5-02-028613-3.

Illustration for (A1)

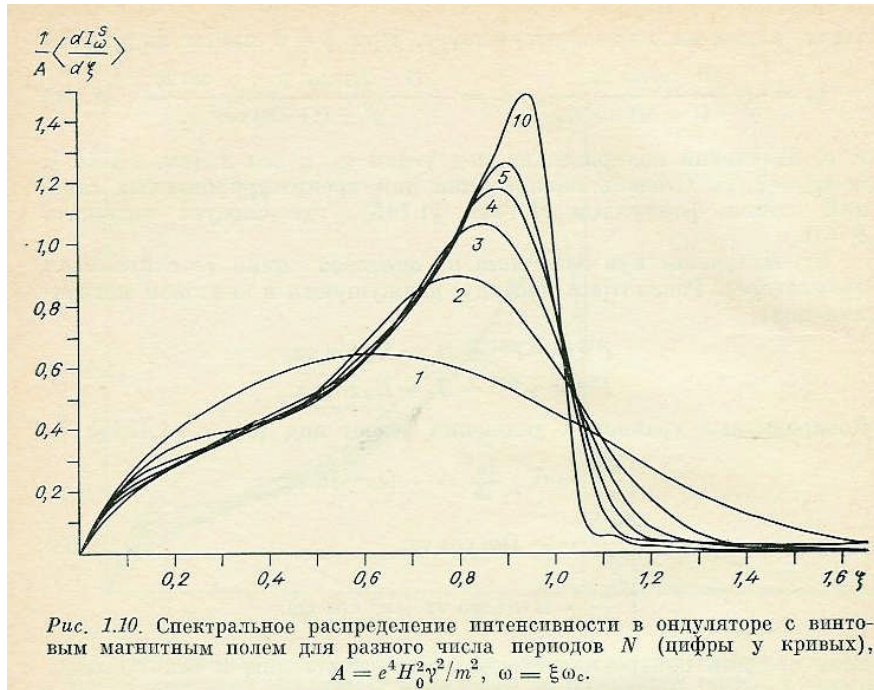

Helical undulator

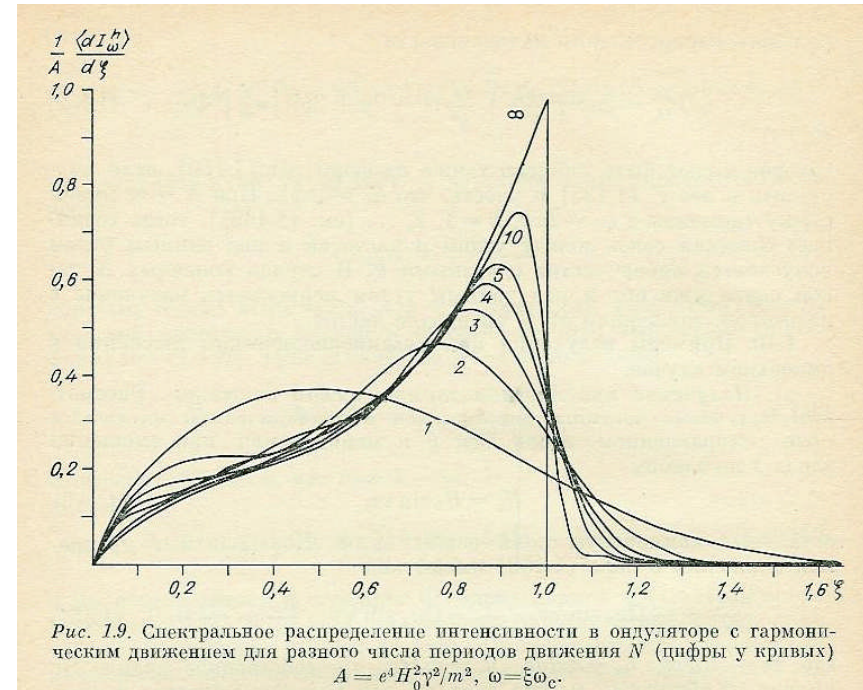

Planar Undulator

[5] V.N.Bayer, V.M.Katkov, V.M.Strakhovenko, “*Electromagnetic Processes at High Energy in Oriented Monocrystals*”, Novosibirsk, Nauka, 1989, ISBN 5-02-028613-3.

SUMMARY

The type of SC undulator described allows easy manipulation by polarization and K factor independently. Ability to change K factor within 0-1.5 allows fine tuning of radiated spectrum. Clean aperture up to 8mm in diameter, provided by smooth surface of Oxygen-free Copper tube. For mostly experiments this ability to manipulate with K factor and polarization might be crucial.

Undulator is inexpensive, having small transverse outer size of cryostat ($\sim 4''$) and fits well in SC RF systems planned at CERN and worldwide. Period $< 20\text{mm}$, single piece length up to 10m , varying K factor *and* polarization allows wide range of experiments to be carried with this device. Period of undulator could be set to any specific value; increase of period allows exponential increase of K factor (indeed, decrease of period for fixed aperture reduces achievable K factor exponentially also). Ratio of aperture diameter to the length of undulator could reach $0.8\text{cm}/1000\text{cm} = 8 \cdot 10^{-4}$, what is the same as successfully operated pulsed undulator fabricated at Cornell for SLAC experiment ($0.8\text{mm}/1000\text{mm}$).

Wiggler with SC windings allows generation of hard x-ray up to 200keV . Usage of graphite collimators allow fine separation of radiation by angles and enhance the energy spectrum. Possibility for generation of elliptically polarized radiation adds to the positive features of this device.

For cooling the wigglers and undulators a Helium transfer line should run along the beamline. This Helium line is pretty much the same as in use for serving 12 SC 2T-wigglers installed in CESR tunnel. This line is inexpensive and can be used for cooling experimental samples if necessary as well. Additional losses of cold at 4.2K associated with 14 wigglers/undulator can be estimated $\sim 150\text{W}$.

BACKUP SLIDES

WIGGLER AS A SERIES OF QUADRUPOLES

